

Job Name: 25-0209 Garrison Gardens  
 Job Location: Bowling Green, KY  
 Contractor: Scotty's Contracting & Stone, LLC

Plant: 100  
 1/23/2026 4:36:17 PM

Tech: J. Horsley - A  
 PC: Celina Goff



**Structure ID: CB 3-7**

**P3 MH048LD12S**

**MH FLAT TOP w/30"x30" Hole F/G**

- P4) 30" x 30" - CASTING HEIGHT - 4"
- P3) 48" - MH FLAT TOP w/30"x30" Hole F/G - 12"
- P2) 48" - MH RISER Custom Ht T/G - 50"
- P1) 48" - MH BASE T/n - 42"
- 1) CASTING - HOE 468 F/G
- 2) 48" - Conseal CS-102 1.00"
- 1) 30" x 30" - Conseal CS-102 1.00"
- 2) Hole - 30
- 1) Hole - 6
- 7) MH Step ML-10-TDS-NCR - 10"

0 lb  
 1350 lb  
 3165 lb  
 3948 lb  
 489 lb  
 0 lb  
 0 lb  
 0 lb  
 0 lb  
 0 lb  
 0 lb  
 -----  
 Structure Total: 8952 lb

- Structure Notes:**
1. PER ASTM C-478 SPECIFICATIONS
  2. CONCRETE: 4,000 PSI AT 28 DAYS
  3. REINFORCEMENT: #4 BAR @ 10" C.C. E.W. (GRADE 60) - 2" MIN. REBAR CLEARANCE (TYP)
  4. HOE 468 FRAME & GRATE SUPPLIED BY ICAST
  5. LIFTERS: 4 EA. WRA016 CONAC WIRE ROPE ANCHORS FOR PLANT & FIELD HANDLING
  6. TOP SURFACE TO RECEIVE FLOATED FINISH

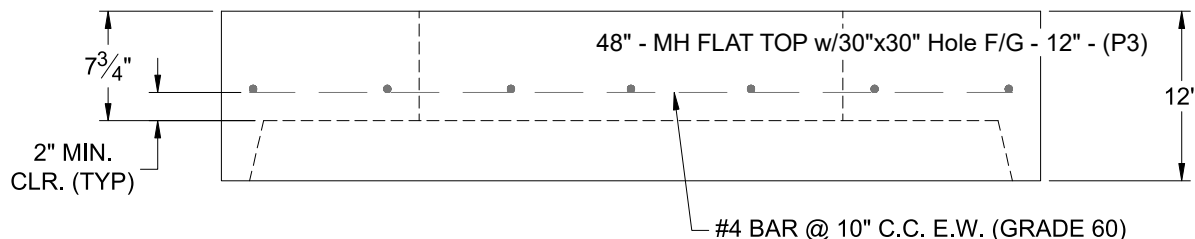
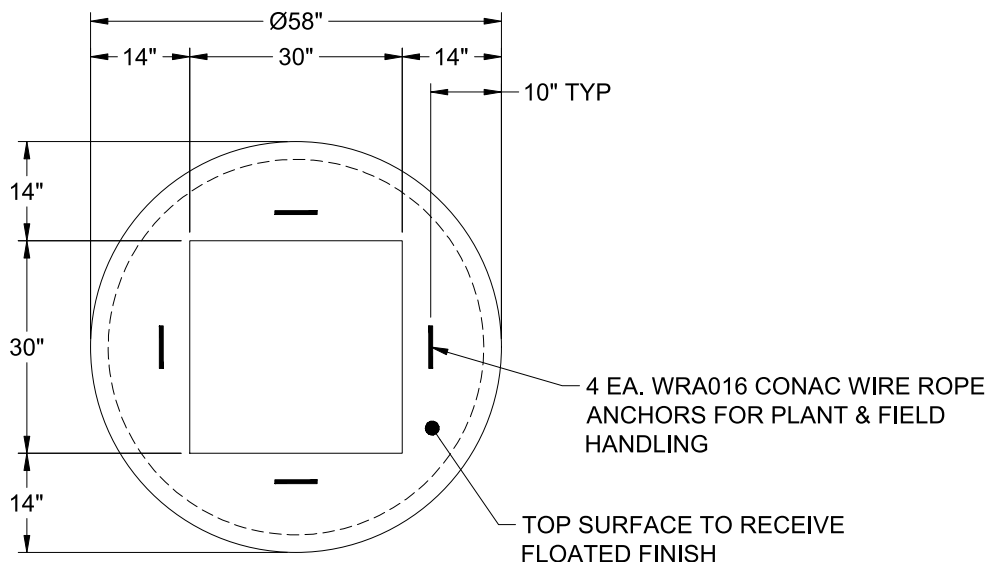

Coating (Int): Coating (Ext):	Seam Up: Flat Seam Dn: Groove	Wall Thickness: 5"	Height (Ext): 12"	Weight (Net): 1350 lb Volume (Net): 0.33cu.yd
----------------------------------	----------------------------------	--------------------	-------------------	--