

Job Name: 24-3925 Heritage Meadows
Job Location: Elizabethtown, KY
Contractor: Phillips Bros. Construction, LLC

PC: T. Ryan
 TECH: J. Horsley
 Plant: Beaver Dam



Structure ID: ARV 04 (48in) 6in FM 35+26

Spec: Sanitary
 Type: Air Release MH
 Size: 48"

Rim: 827.7'
 Invert: 822.48'
 Rim to Invert: 5.22'

Sump: 3.996"
 Floor (Top): 822.147'
 Floor Height: 0"

Floor (Bot): 822.147'
 Overall Height: 5.5'
 Slack: 0.636"

Structure Notes:

1. PER ASTM C478 SPECIFICATIONS.
2. CONCRETE = 4,000 PSI AT 28 DAYS.
3. CASTING SUPPLIED BY OTHERS (HOE MC-375 F/C).

REINFORCING PER ASTM A615 (GRADE 60).
 - CONE (As .12)
 - RISER (As .12)
 - FLOOR (As .31) #5 BARS AT 12" C.C.E.W.

STRUCTURE SUMMARY:

P4) 24" - CASTING HEIGHT - 7"	0 lb
P3) 48" - MH FLAT TOP w/ 24" ECC Hole F/G - 12"	1561 lb
P2) 48" - MH DH RISER Custom Ht T/F - 47"	3191 lb
P1) 48" - P.I.P. BY OTHERS - BTM SLAB F/n - 0"	0 lb
1) JOINT WRAP - 0.065"x6"x50' CONSEAL CS212	0 lb
1) JOINT WRAP PRIMER - CONSEAL CS-75 (1 gal.)	0 lb
2) 48" - Conseal CS-102 1.00" (Double)	0 lb
2) DOGHOUSE - 10"x10"	0 lb
4) MH Step ML-10-TDS-NCR - 10"	0 lb
Structure Total:	4752 lb

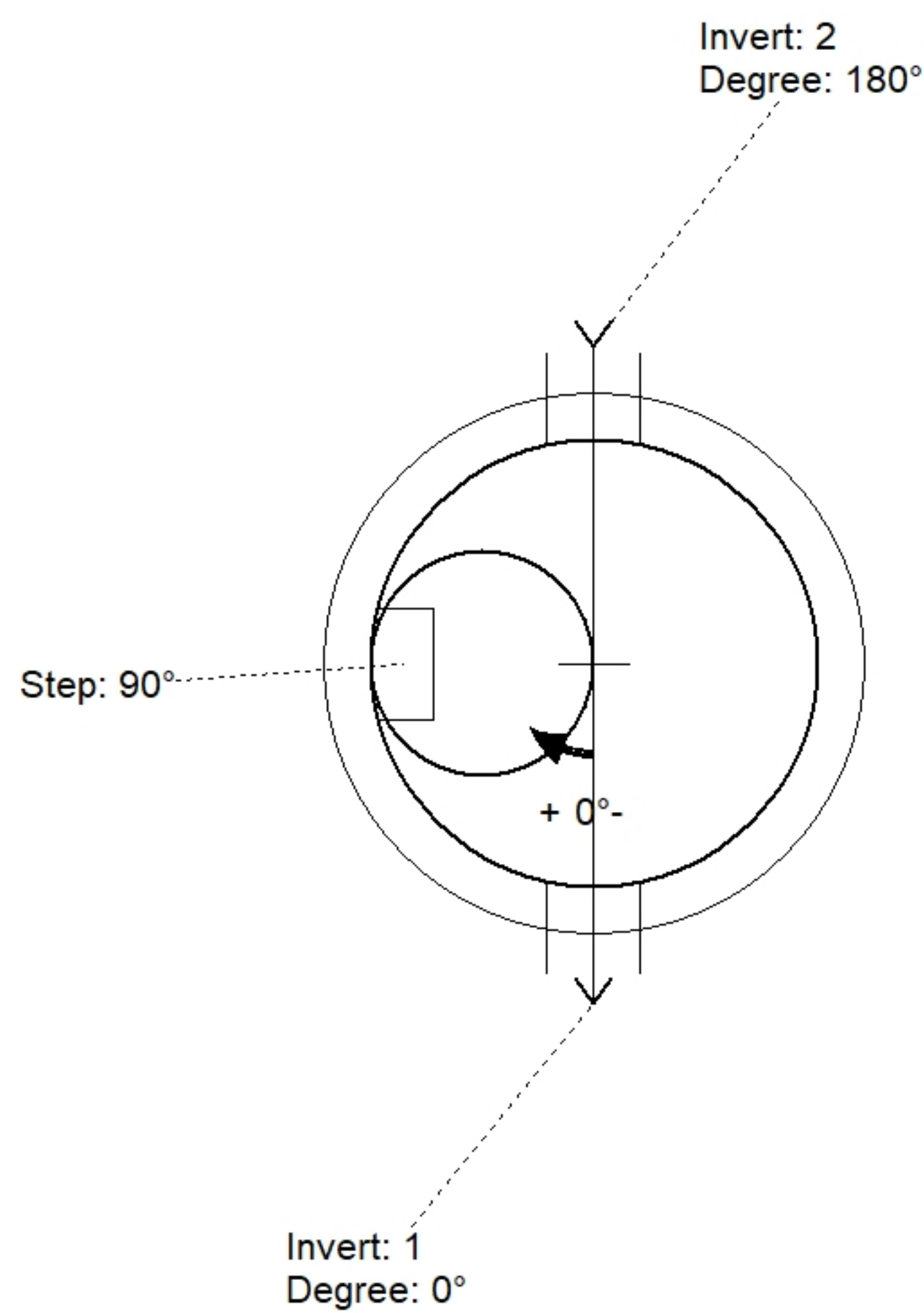

Position	Elev	Angle	Pipe	Pipe OD	Hole	Connector	Up (")	Ref
Rim	827.7'							
Reducer								
Invert 1	822.48'	0°	6" C900 DR18	6.9"	10" x 10"	DOGHOUSE 10"x10"	2"	P2
Invert 2	822.48'	180°	6" C900 DR18	6.9"	10" x 10"	DOGHOUSE 10"x10"	2"	P2
Invert 3								
Invert 4								
Invert 5								
Invert 6								
Invert 7								
Invert 8								

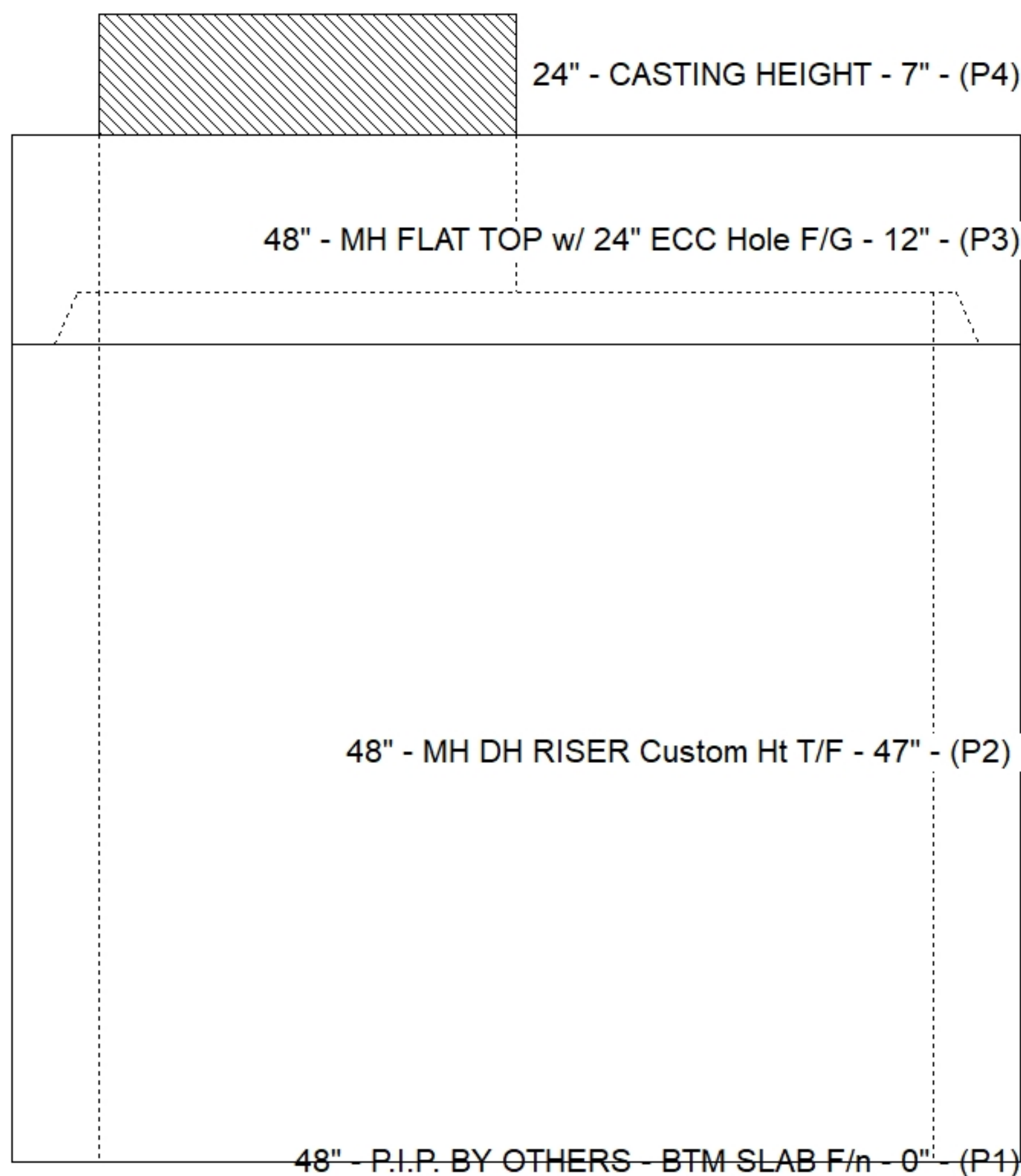

Cast (Int. Dim.) - Interior Dimensions

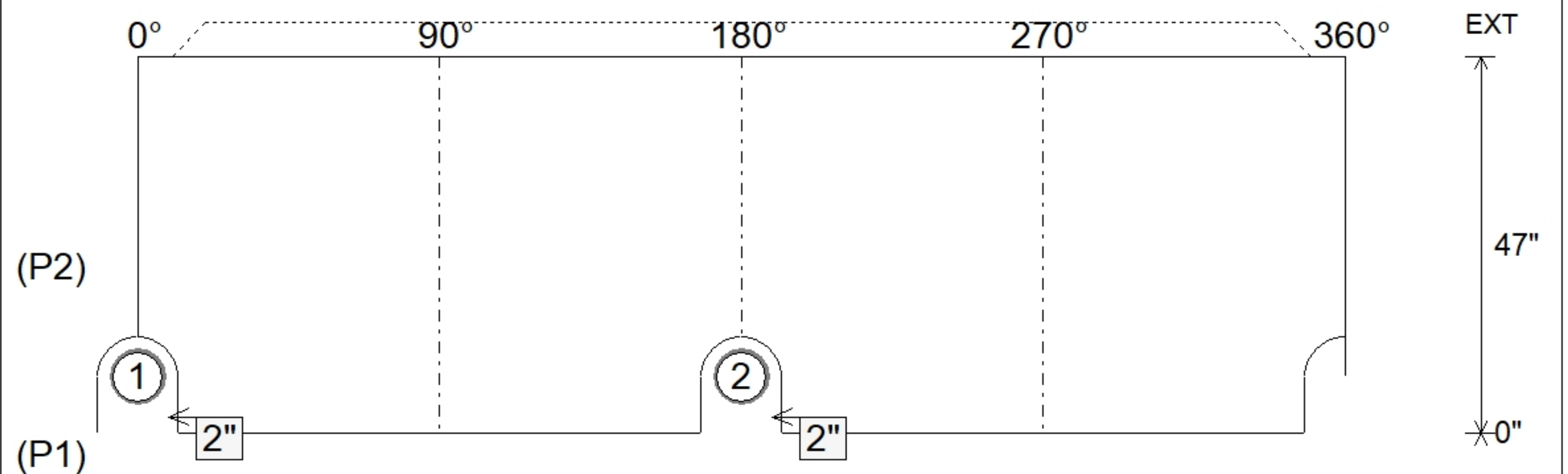

Submittal Drawing
 10/21/2025 4:52:16 PM

SUBMITTAL
 APPROVED BY: