

Job Name: 24-3781 Anderson Park At Indian Lake
Job Location: Hendersonville, TN
Contractor: Apex

PC: A. Chambers
 TECH: J. Coppage
 Plant: Beaver Dam



Structure ID: **89**
 Spec: KO BOXES
 Type: BX 6inW, 6inF
 Size: 30" x 30"

Rim: 0'
 Invert: 0'
 Rim to Invert: 0'

Sump: 48"
 Floor (Top): -4'
 Floor Height: 6"

Floor (Bot): -4.5'
 Overall Height: 4.5'
 Slack: 0"

Structure Notes:

1. PER ASTM C913 SPECIFICATIONS.
2. CONCRETE = 4,000 PSI AT 28 DAYS.
3. NO INVERT CHANNEL.
4. REINFORCING PER ASTM A615 (GRADE 60).
 - TOP SLAB (As .62) #5 BARS AT 6" C.C.E.W.
 - WALLS (As .12) #5 BARS AT 12" C.C.E.W.
 - FLOOR (As .12) #5 BARS AT 12" C.C.E.W.

STRUCTURE SUMMARY:

P2) 30" x 30" - CASTING HEIGHT - 6" 0 lb
 P1) 30" x 30" - KNOCKOUT BASE 6"W/F - STOCK - 42" 2564 lb
 1) CASTING - JBS 4310 F/G 500 lb
 1) 30" x 30" - Conseal CS-102 1.00" 0 lb
 Structure Total: 3064 lb

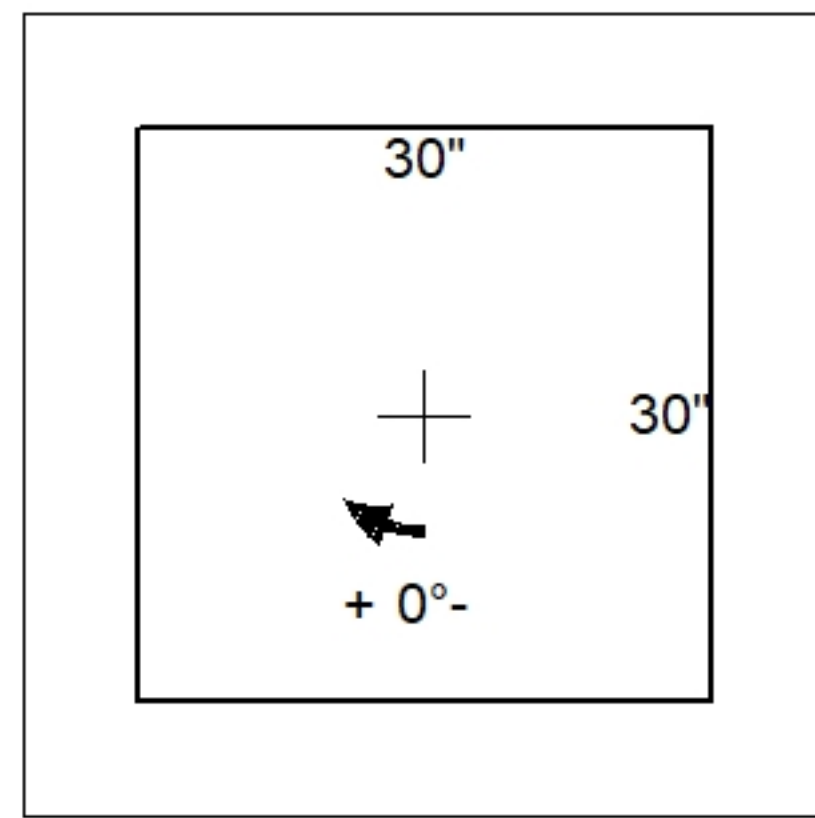

Position	Elev	Angle	Pipe	Pipe OD	Hole	Connector	Up ()	Ref
Rim	0'							
Reducer								
Invert 1								
Invert 2								
Invert 3								
Invert 4								
Invert 5								
Invert 6								
Invert 7								
Invert 8								

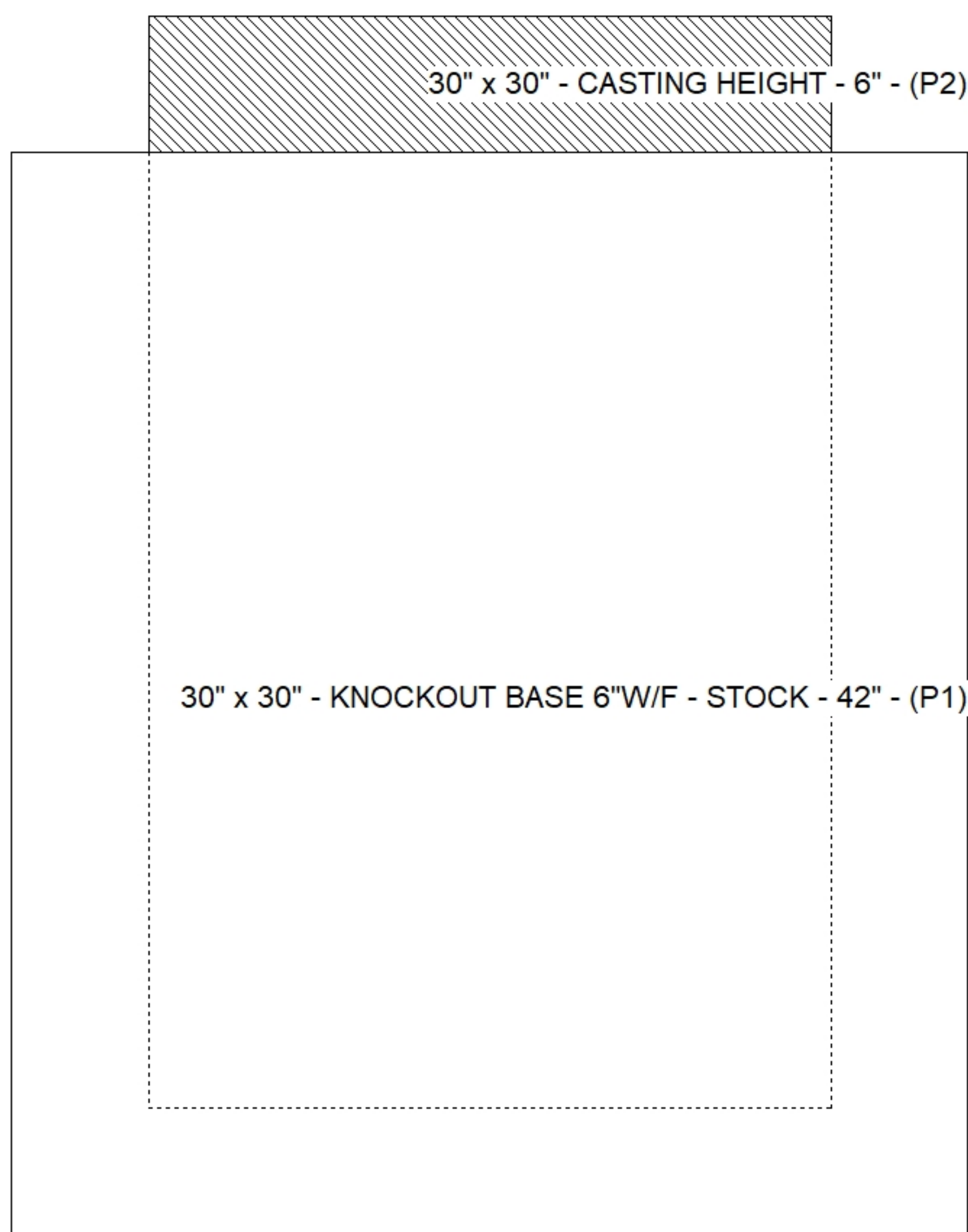

Default - Interior Dimensions

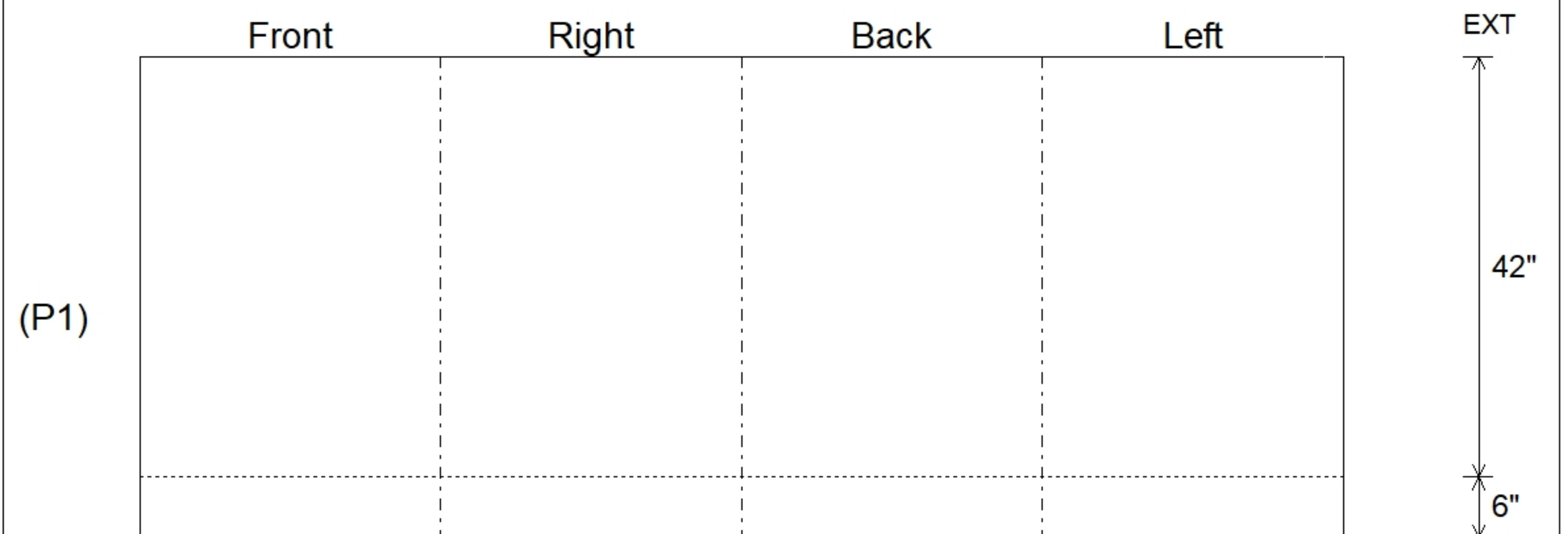

Submittal Drawing
 10/23/2025 10:26:27 AM

SUBMITTAL
 APPROVED BY: