

**Structure ID: MWV 05**

**P1 P.I.P. BY OTHERS - BTM SLAB**

P5) 24" - CASTING HEIGHT - 7"	0 lb	<u>Structure Notes:</u>       
P4) 78" x 84" - CB FLAT TOP 8"W w/(2) 24" HOLES - 8"	5703 lb	
P3) 78" x 84" - BOX RISER 8inW, Variable Ht - 12"	2868 lb	
P2) 78" x 84" - BOX RISER 8inW, Variable Ht - 53"	10919 lb	
P1) 78" x 84" - P.I.P. BY OTHERS - BTM SLAB - 0"	0 lb	
2) 24" x 120" - FOOTING SLAB 24"x120"x8" - BLKCSTM	3856 lb	
2) DOGHOUSE - 54"x27"	0 lb	
Structure Total:	23345 lb	

Rim: 7.33'    Rim to Invert: 7.33'    Slack: 9.335"    Sump: 1.375"    Step Position:

Position	Elev	Angle	Ext. (cw)	Pipe	Pipe OD	Connector	Hole	Horz Size	Up (L)	Offset
Invert 1										
Invert 2										
Invert 3										
Invert 4										
Invert 5										
Invert 6										
Invert 7										
Invert 8										

RIGHT-SIDE UP VIEW (int. dimensions)

UPSIDE-DOWN VIEW (int. dimensions)

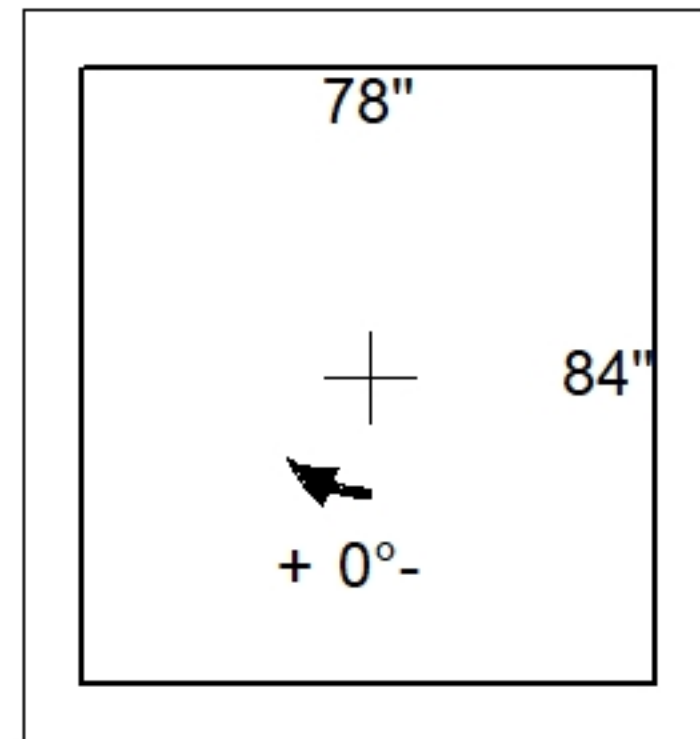
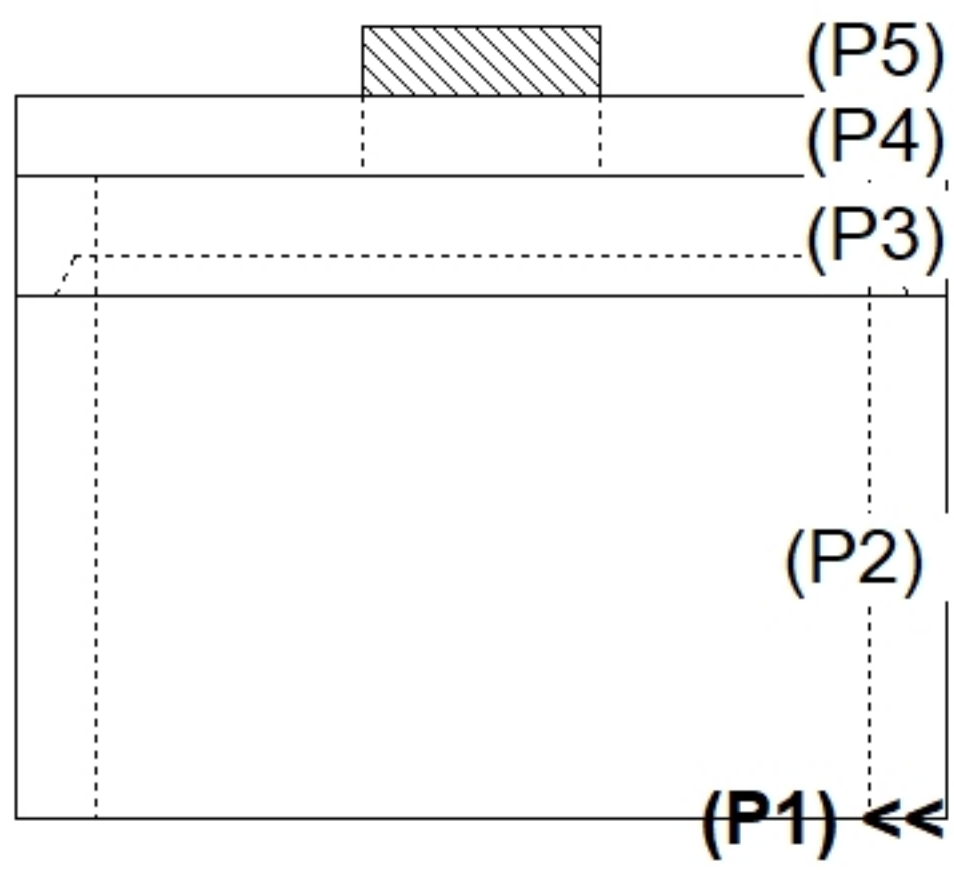

INSIDE WALL DIMENSIONS

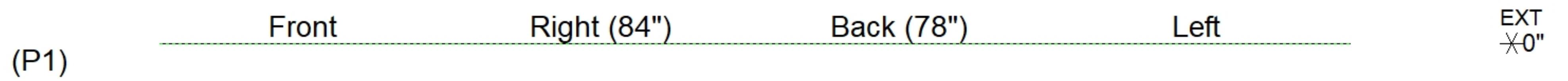

Coating (Int):	Seam Up: Flat	Wall Thickness: 8"	Height (Int): 0"	Weight (Net): 0 lb
Coating (Ext):	Seam Dn: n/a	Floor Height: 0"	Height (Ext): 0"	Volume (Net): 0cu.yd