

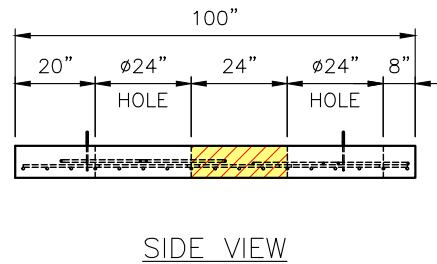

NOTES:

1. MANUFACTURED PER ASTM C913 SPECIFICATIONS.
2. CONCRETE: 4,000 PSI AT 28 DAYS.
3. OPEN BOTTOM STRUCTURE.
4. JOINT SEALANT: 1" BUTYL CS-102.
5. REINFORCING PER ASTM A615 (GRADE 60).
TOP SLAB (As .62) #5 BARS AT 6" C.C.E.W.
6. WEIGHT:
FLAT TOP.....5,703 LBS
7. NO STEPS

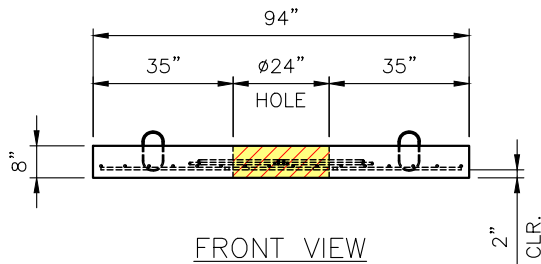
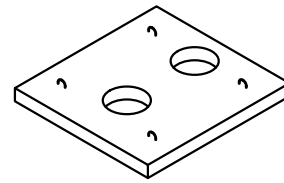
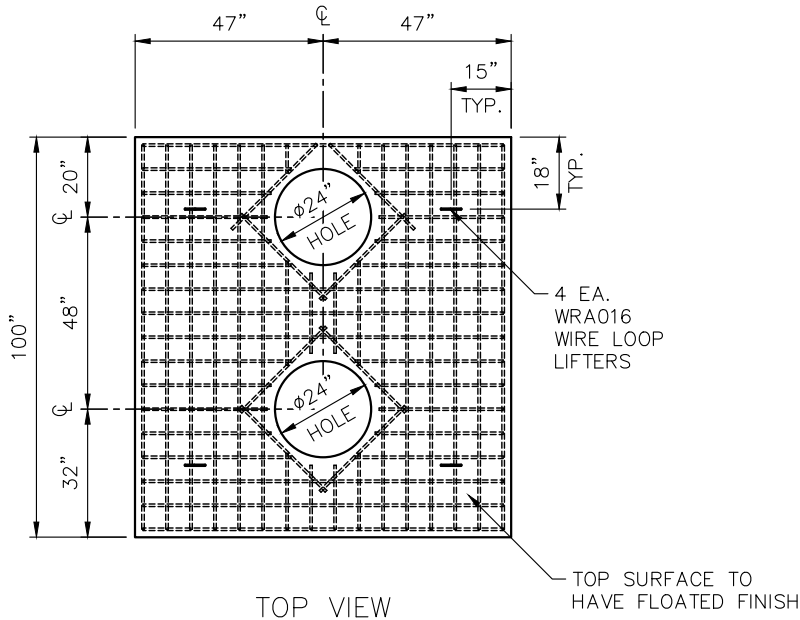

MWV 02 - 45+45 E. ST. CATHERINE ST.

PRODUCTION WORK ORDER		PRODUCT I.D.: CVT	DESCRIPTION: FLAT TOP 94"x100"x8"H F/F		
	QUALITY CONTROL CHECKLIST	PRODUCT VIEW: RIGHT SIDE UP	CUSTOMER: GARNEY COMPANIES		
	<input type="checkbox"/> ALL DIMENSIONS CORRECT. <input type="checkbox"/> LIFTERS INSTALLED. <input type="checkbox"/> OPENING CENTERED. <input type="checkbox"/> REINFORCING CORRECT. <input type="checkbox"/> SURFACE QUALITY ACCEPTABLE. <input type="checkbox"/> EDGES CHAMFERED. <input type="checkbox"/> ALL PATCHWORK ACCEPTABLE.	PLANT: BEAVER DAM, KY.	PROJECT: KY OAK GLENMARY 48" MAIN REHAB PH.2		
		WEIGHT: 5,703 LBS.	STRUCTURE: MWV 04 - P3		
		TOP SECTION JOINT: N/A	ORDER NO: 24-2570		
		BASE SECTION JOINT: FLAT	PC: A. CHAMBERS	DRAWING: M. BILITER	
		QC CHECK INITIALS:	DATE: 02/26/25	SCALE: NTS	PG. 1 of 1