

Job Name: 24-1632 - KYTC Letting Call 100 (241306) Sanitary  
 Job Location: Jackson, KY 41339  
 Contractor: Triton Construction, Inc.

Plant: Beaver Dam, KY  
 4/20/2026 11:53:44 AM

Tech: K. Cardwell  
 PC: C. Goff



**Structure ID: ARV 564+54.55**

**P3 MH048LD12ECC**

**MH FLAT TOP w/ 24" ECC Hole F/G**

- P4) 24" - CASTING HEIGHT - 7"
- P3) 48" - MH FLAT TOP w/ 24" ECC Hole F/G - 12"
- P2) 48" - MH RISER Custom Ht T/F - 50"
- P1) 48" - P.I.P. BY OTHERS - BTM SLAB F/n - 0"
- 1) CASTING - HOE MC-350 F/C Sanitary
- 2) 48" - Conseal CS-102 1.00" (Double)
- 2) DOGHOUSE - 10"x16"
- 4) MH Step ML-10-TDS-NCR - 10"

0 lb  
 1561 lb  
 3367 lb  
 0 lb  
 305 lb  
 0 lb  
 0 lb  
 0 lb  
 -----  
 5233 lb

Structure Total:

- Structure Notes:  
 STATION: 564+54.55 (0+76)
1. PER KYTC & ASTM C-478 SPECIFICATIONS
  2. CONCRETE: 5,000 PSI AT 28 DAYS
  3. REINFORCEMENT: #4 BAR @ 10" C.C. E.W. (GRADE 60) - 2" MIN. REBAR CLEARANCE (TYP)
  4. HOE MC-350 FRAME & COVER "SANITARY" SUPPLIED BY ICAST
  5. LIFTERS: 3 EA. WRA016 CONAC WIRE ROPE ANCHORS FOR PLANT & FIELD HANDLING
  6. TOP SURFACE TO RECEIVE FLOATED FINISH

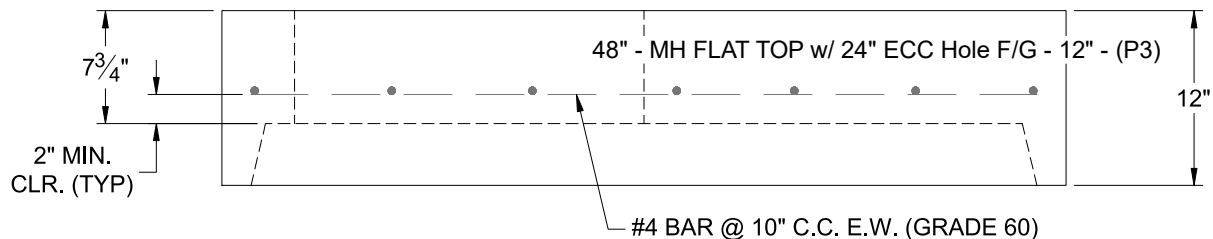
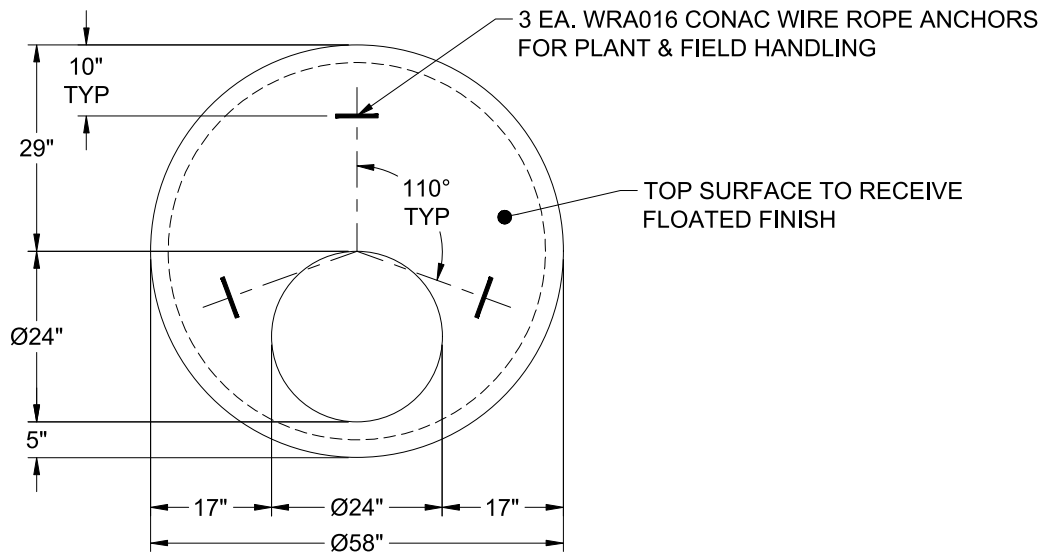

Coating (Int):  
 Coating (Ext):

Seam Up: Flat  
 Seam Dn: Groove

Wall Thickness: 5"

Height (Ext): 12"

Weight (Net): 1561 lb  
 Volume (Net): 0.42cu.yd