

Job Name: 24-1632 - KYTC Letting Call 100 (241306) Sanitary
 Job Location: Jackson, KY 41339
 Contractor: Triton Construction, Inc.

Plant: Beaver Dam, KY

Tech: K. Cardwell

4/20/2026 11:00:26 AM

PC: C. Goff



Structure ID: ARV 560+59.95

P2 MH048RSVF

MH RISER Custom Ht T/F

- P4) 24" - CASTING HEIGHT - 7"
- P3) 48" - MH FLAT TOP w/ 24" ECC Hole F/G - 12"
- P2) 48" - MH RISER Custom Ht T/F - 50"
- P1) 48" - P.I.P. BY OTHERS - BTM SLAB F/n - 0"
- 1) CASTING - HOE MC-350 F/C Sanitary
- 2) 48" - Conseal CS-102 1.00" (Double)
- 2) DOGHOUSE - 10"x16"
- 4) MH Step ML-10-TDS-NCR - 10"

0 lb
 1561 lb
 3367 lb
 0 lb
 305 lb
 0 lb
 0 lb
 0 lb
 0 lb
 Structure Total: 5233 lb

- Structure Notes:**
 STATION: 560+59.95 (46+00)
 1. PER KYTC & ASTM C-478 SPECIFICATIONS
 2. CONCRETE: 5,000 PSI AT 28 DAYS
 3. REINFORCEMENT: PER ASTM A615
 4. STEPS AT 90 DEGREES
 5. HOE MC-350 FRAME & COVER "SANITARY" SUPPLIED BY ICAST
 6. DOGHOUSE OPENINGS: 10" WIDE X 16" TALL

Rim: 5.75' Rim to Invert: 5.083' Slack: 0" Sump: 8" Step Position: 90°

Position	Elev	Angle	Ext. (cw)	Pipe	Pipe OD	Connector	Hole	Horz Size	Up ()	Offset
Invert 1	0.667'	0°	0"	6" PVC SDR21	6.625"	DOGHOUSE 10"x16"	10" x 16"	10.074"	0"	0"
Invert 2	0.667'	180°	91.125"	6" PVC SDR21	6.625"	DOGHOUSE 10"x16"	10" x 16"	10.074"	0"	0"
Invert 3										
Invert 4										
Invert 5										
Invert 6										
Invert 7										
Invert 8										

RIGHT-SIDE UP VIEW (int. dimensions)

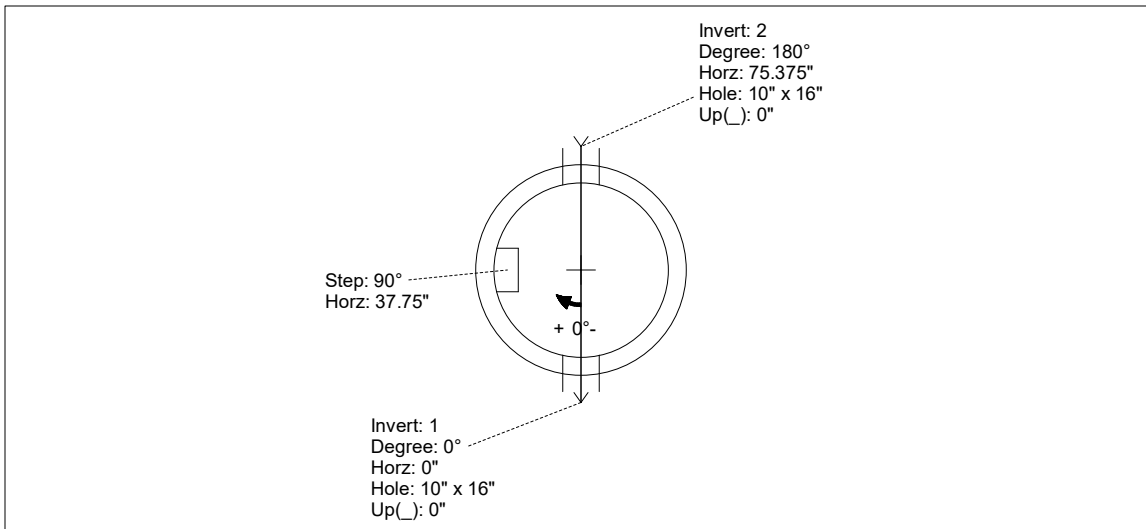
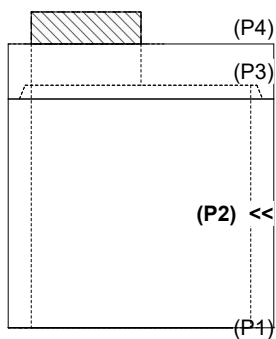

INSIDE WALL DIMENSIONS

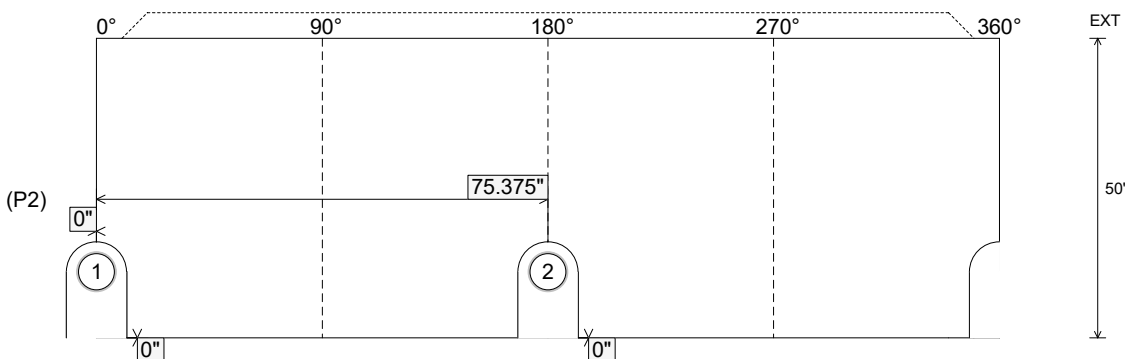

Coating (Int):
 Coating (Ext):

Seam Up: Tongue
 Seam Dn: Flat

Wall Thickness: 5"
 Floor Height: 0"

Height (Int): 50"
 Height (Ext): 50"

Weight (Net): 3367 lb
 Volume (Net): 0.86cu.yd