

Job Name: 24-1632 - KYTC Letting Call 100 (241306) Sanitary
Job Location: Jackson, KY 41339
Contractor: Triton Construction, Inc.

PC: C. Goff
 TECH: K. Cardwell
 Plant: Beaver Dam, KY



Structure ID: **ARV 559+36.96**

Spec: Sanitary
 Type: SAN.MH (OPEN BTM)
 Size: 48"

Rim: 5.75'
 Invert: 0.667'
 Rim to Invert: 5.083'

Sump: 8"
 Floor (Top): 0'
 Floor Height: 0"

Floor (Bot): 0'
 Overall Height: 5.75'
 Slack: 0"

Structure Notes:

- STATION: 559+36.96 (44+77)
- 1. PER KYTC & ASTM C-478 SPECIFICATIONS
- 2. CONCRETE: 5,000 PSI AT 28 DAYS
- 3. REINFORCEMENT:
 - FLAT LID: #4 BAR @ 10" C.C. E.W. (GRADE 60)
 - RISER: PER ASTM A615
- 4. STEPS AT 90 DEGREES
- 5. HOE MC-350 FRAME & COVER "SANITARY" SUPPLIED BY ICAST
- 6. DOGHOUSE OPENINGS: 10" WIDE X 16" TALL

STRUCTURE SUMMARY:

P4) 24" - CASTING HEIGHT - 7"	0 lb
P3) 48" - MH FLAT TOP w/ 24" ECC Hole F/G - 12"	1561 lb
P2) 48" - MH RISER Custom Ht T/F - 50"	3367 lb
P1) 48" - P.I.P. BY OTHERS - BTM SLAB F/n - 0"	0 lb
1) CASTING - HOE MC-350 F/C Sanitary	305 lb
2) 48" - Conseal CS-102 1.00" (Double)	0 lb
2) DOGHOUSE - 10"x16"	0 lb
4) MH Step ML-10-TDS-NCR - 10"	0 lb
Structure Total:	5233 lb

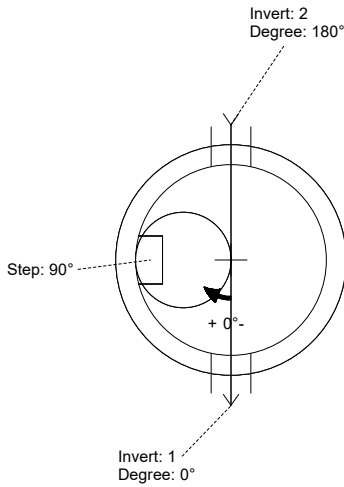

Position	Elev	Angle	Pipe	Pipe OD	Hole	Connector	Up (L)	Ref
Rim	5.75'							
Reducer								
Invert 1	0.667'	0°	6" PVC SDR21	6.625"	10" x 16"	DOGHOUSE 10"x16"	0"	P2
Invert 2	0.667'	180°	6" PVC SDR21	6.625"	10" x 16"	DOGHOUSE 10"x16"	0"	P2
Invert 3								
Invert 4								
Invert 5								
Invert 6								
Invert 7								
Invert 8								

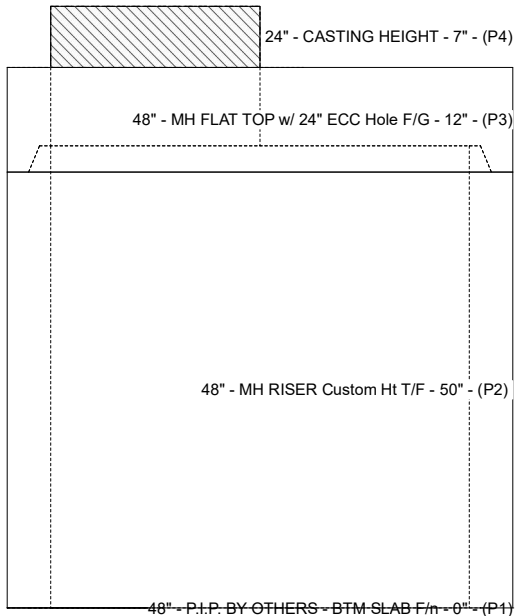

Cast (Int. Dim.) - Interior Dimensions

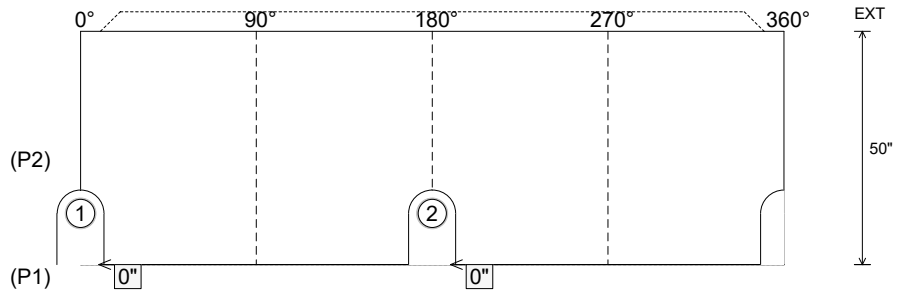

Submittal Drawing
 4/20/2026 9:33:34 AM

SUBMITTAL
 APPROVED BY: