

Job Name: 24-1260 - Combined Sewer Separation Project Ph 3
 Job Location: Morganfield, KY 42437
 Contractor: Deig Bros Lumber & Construction Co, Inc.

Plant: Beaver Dam, KY
 10/13/2025 2:08:38 PM

Tech: K. Cardwell
 PC: J. Jarvis



Structure ID: STMH 12+20

P3 MH060LD13

MH FLAT LID w/24in ECC Hole F/G

- P4) 24" - CASTING HEIGHT - 8"
- P3) 60" - MH FLAT LID w/24in ECC Hole F/G - 13"
- P2) 60" - MH RISER T/G - 18"
- P1) 60" - MH BASE w/FLANGE (08F/07EF) T/n - 64"
- 1) 60" - EXT. FLG (60ø MH) 7"WD/8"THK
- 1) CASTING - HOE KY-510 F/C (KY TY.2)
- 2) 60" - Conseal CS-102 1.00"
- 2) Hole - 48
- 2) Hole - 18
- 7) MH Step ML-10-TDS-NCR - 10"

0 lb
 2800 lb
 1879 lb
 7101 lb
 1167 lb
 510 lb
 0 lb
 0 lb
 0 lb
 0 lb

 Structure Total: 13457 lb

- Structure Notes:
 STATION: 12+20 STORM LN A
1. PER KYTC MH B / ASTM C-913 SPECS
 2. CONCRETE: 5,000 PSI AT 28 DAYS
 3. REINFORCEMENT: #5 BAR @ 6" C.C. E.W. (GRADE 60) - 2" MIN. REBAR CLEARANCE (TYP)
 4. STORM INVERT BY OTHERS
 5. STEPS AT 75 DEGREES
 6. KY-510 FRAME & COVER SUPPLIED BY ICAST
 7. LIFTERS: 3 EA. WRA016 CONAC WIRE ROPE ANCHORS FOR PLANT & FIELD HANDLING

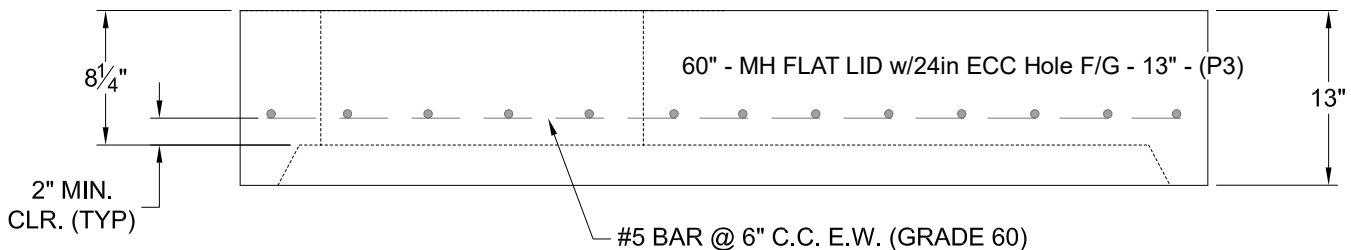
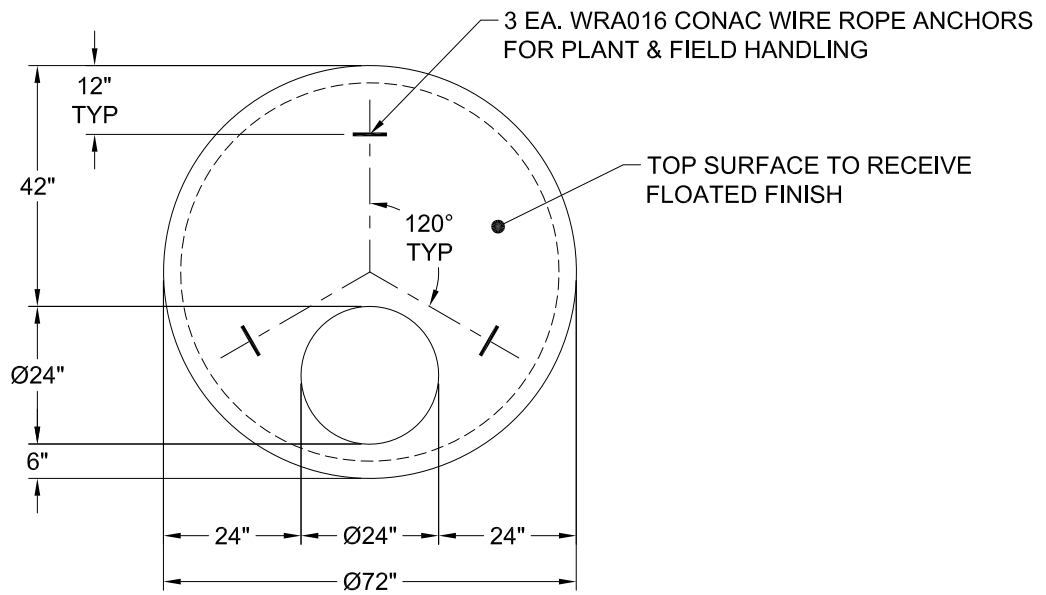

Coating (Int): Coating (Ext):	Seam Up: Flat Seam Dn: Groove	Wall Thickness: 6"	Height (Ext): 13"	Weight (Net): 2800 lb Volume (Net): 0.69cu.yd
----------------------------------	----------------------------------	--------------------	-------------------	--