

Job Name: 24-1042B - Azteca  
 Job Location: Evansville, IN 47725  
 Contractor: Deig Bros Lumber & Construction Co, Inc.

Plant: Beaver Dam, KY  
 10/21/2025 3:45:56 PM

Tech: K. Cardwell  
 PC: A. Chambers



**Structure ID: 2-1042B 2**

**P3 MH048LD12ECC**

**MH FLAT TOP w/ 24" ECC Hole F/G**

- P4) 24" - CASTING HEIGHT - 7"
- P3) 48" - MH FLAT TOP w/ 24" ECC Hole F/G - 12"
- P2) 48" - MH RISER Custom Ht T/F - 51"
- P1) 48" - P.I.P. BY OTHERS - BTM SLAB F/n - 0"
- 1) JOINT WRAP PRIMER - CONSEAL CS-75 (1 gal.)
- 1) JOINT WRAP - 0.065"x6"x50' CONSEAL CS212
- 1) CASTING - HOE MC-315 F/C Sanitary
- 2) 48" - Conseal CS-102 1.00" (Double)
- 2) DOGHOUSE - 10"x12"

0 lb  
 1561 lb  
 3472 lb  
 0 lb  
 0 lb  
 0 lb  
 258 lb  
 0 lb  
 0 lb  
 -----  
 Structure Total: 5291 lb

- Structure Notes:
1. PER ASTM C-478 SPECS
  2. CONCRETE: 4,500 PSI AT 28 DAYS
  3. REINFORCEMENT: PER ASTM A615
  4. NO STEPS
  5. HOE MC-315 FRAME & COVER "SANITARY" SUPPLIED BY ICAST
  6. LIFTERS: 3 EA. WRA016 CONAC WIRE ROPE ANCHORS FOR PLANT & FIELD HANDLING

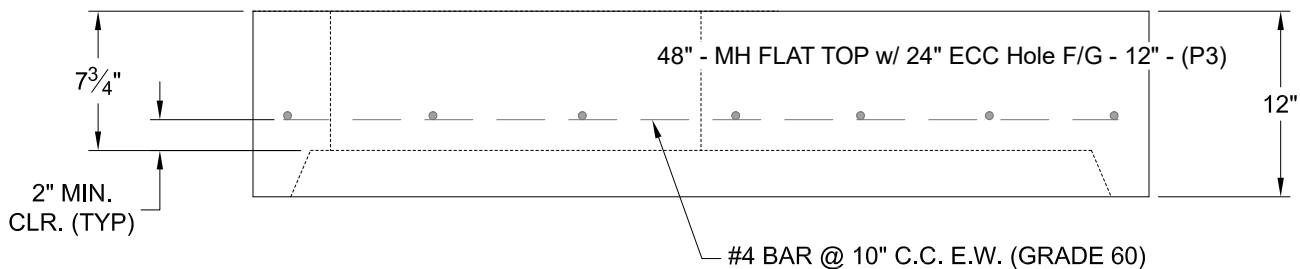
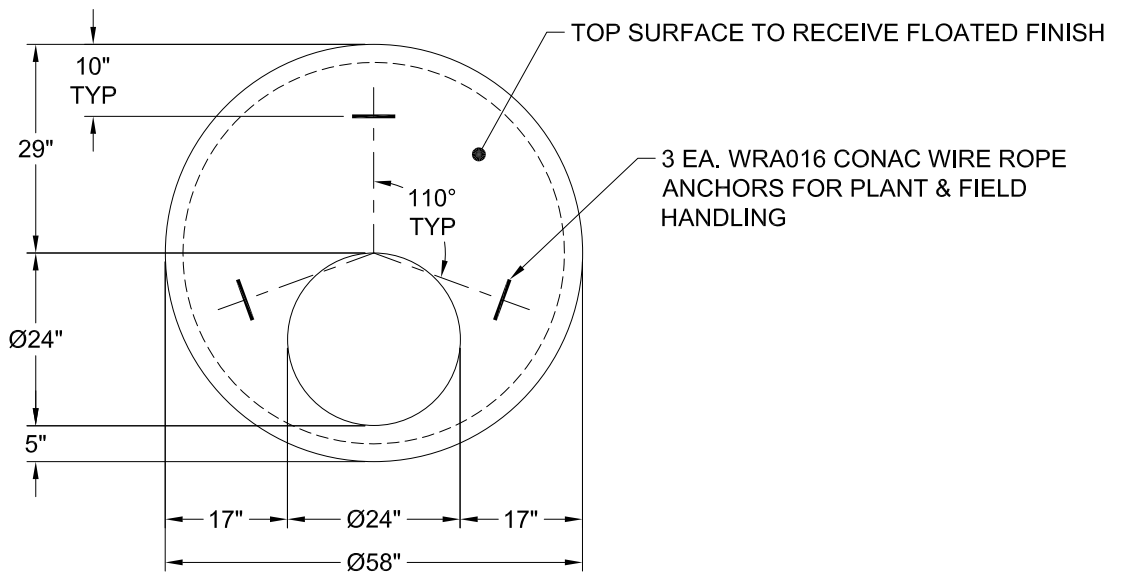

Coating (Int): Coating (Ext):	Seam Up: Flat Seam Dn: Groove	Wall Thickness: 5"	Height (Ext): 12"	Weight (Net): 1561 lb Volume (Net): 0.42cu.yd
----------------------------------	----------------------------------	--------------------	-------------------	--