

Job Name: 24-4171 - McKinney Water District Contract 1B Phase 2
 Job Location: Stanford, KY
 Contractor: Frederick and May Construction

Plant: 100
 5/5/2026 8:17:54 PM

Tech: Jared - F
 PC: E. Bradley



Structure ID: METER VAULT - 1

P2 BX4884-06LD08-SP

CB FLAT TOP 6"W w/36"x60" HATCH F/F

- P3) 36" x 60" - HATCH (CAST FLUSH) - 3"
- P2) 48" x 84" - CB FLAT TOP 6"W w/36"x60" HATCH F/F - 8"
- P1) 48" x 84" - BOX BASE 6inW, 6inF, Variable Ht F/n - 54"
- 1) HATCH (Alum.) - HALLIDAY W1S 36"x60"
- 1) 48" x 84" - Conseal CS-102 1.00" (Double)
- 1) 36" x 60" - Conseal CS-102 1.00" (Double)
- 2) Hole - 6

100 lb
 2417 lb
 10702 lb
 116 lb
 0 lb
 0 lb
 0 lb

 Structure Total: 13334 lb

Structure Notes:
 1. PER ASTM C913 SPECIFICATIONS.
 2. CONCRETE = 4,000 PSI AT 28 DAYS.
 3. NO STEPS AND NO INVERT CHANNEL.
 4. HATCH SUPPLIED BY ICAST (HALLIDAY W1S 36"x60").

REINFORCING PER ASTM A615 (GRADE 60).
 - TOP SLAB (As .62) #5 BARS AT 6" C.C.E.W.
 - WALLS (As .12) #5 BARS AT 12" C.C.E.W.
 - FLOOR (As .12) #5 BARS AT 12" C.C.E.W.

GENERAL NOTES:

1. MANUFACTURED TO ASTM C-913 (LATEST REVISION).
2. CONCRETE: 4,000 PSI AT 28 DAYS.
3. REINFORCING: #5 BAR @ 6" E.W. O.C. (GRADE 60).
4. HATCH: HALLIDAY W1S 36" X 60" HATCH PROVIDED BY ICAST
5. HATCH TO BE CAST INTO TOP OF LID.

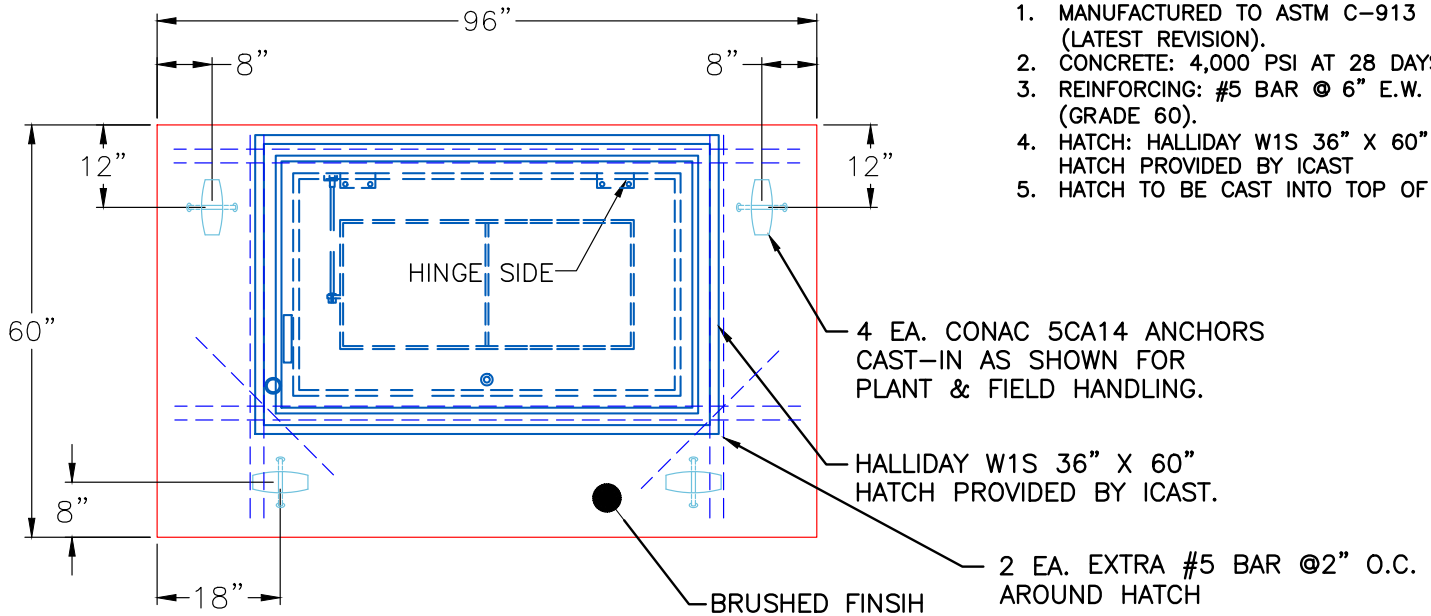

PLAN VIEW

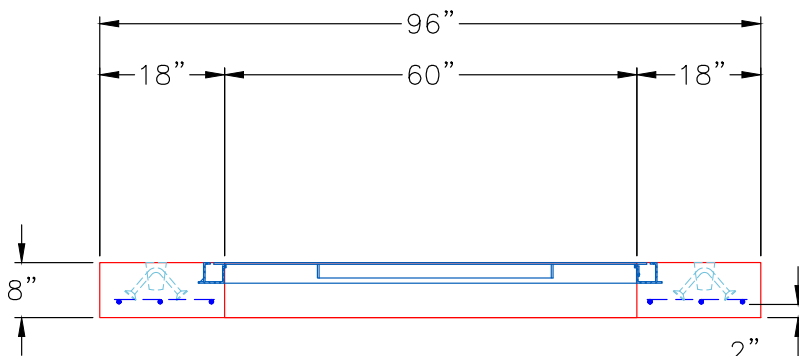

FRONT VIEW

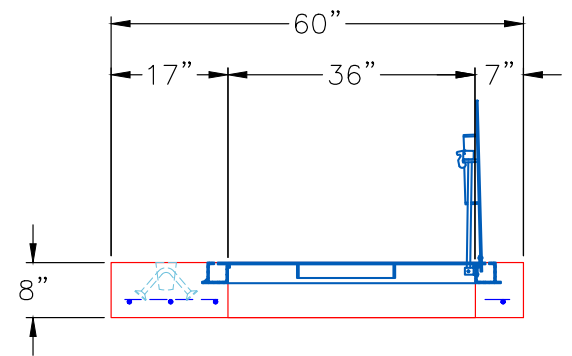

RIGHT VIEW

Coating (Int):
 Coating (Ext):

Seam Up: Flat
 Seam Dn: Flat

Wall Thickness: 6"

Height (Ext): 8"

Weight (Net): 2417 lb
 Volume (Net): 0.62cu.yd